

Congratulations on selecting the BR200 from RCA Communications Systems - The most trusted name in radio!

The BR200 series of business communications products are premium radio products made to perform flawlessly under the most demanding commercial conditions. Cutting edge design, professional grade materials and components, simple operation and superior assembly quality - RCA Communications Systems Products have it all, including our exclusive, no-nonsense, three-year "Warranty Protection Program," one of the most comprehensive warranties in the communications industry.

To ensure you achieve maximum performance from your BR200 radio, please be sure to carefully read this manual.

MODELS COVERED IN THIS MANUAL:

- BR200V – 136-174MHz VHF Two-Way Radio
- BR200U – 400-470 MHz UHF Two-Way Radio
- BR200U2 – 450-520 MHz UHF Two-Way Radio



CONTENTS

SAFETY AND GENERAL INFORMATION	3	Battery Save Mode	16
PRODUCT INSPECTION	4	Channel Annunciation	16
RCA BR200 OVERVIEW	5	CTCSS/DCS.....	16
PREPARING YOUR RADIO FOR INITIAL USE	6	Low Battery Warning	16
Setting Up The Charger	6	Priority Scan	16
Charging the Battery	7	Man-Down.....	17
Battery Caution	8	Scan	17
Battery Storage	9	Temporarily Delete Noise Channel	17
Attaching the Battery	9	TOT (Time-out Timer)	17
Attaching/Removing the Antenna	10	TOT Dispatch Time.....	17
Attaching/Removing the Belt Clip	10	TOT Re-key.....	17
Connecting External Accessories	11	TOT Pre-alert	18
BASIC OPERATIONS.....	11	TOT Reset.....	18
Turn Radio On/Off	11	TROUBLESHOOTING	18
Adjusting the Volume	12	CARE AND CLEANING	19
Select a Channel.....	12	ACCESSORIES.....	20
Make a Call	12	WARRANTY STATEMENT.....	26
Receive a Call.....	13	RF Exposure Compliance.....	28
PROGRAMMABLE BUTTONS	13	SPECIFICATIONS	30
OTHER PROGRAMMABLE FEATURES	16		

SAFETY AND GENERAL INFORMATION

Please read the entire user manual before operating the radio. This radio is restricted to occupational use only to satisfy FCC RF energy exposure requirements. Before using this product, read the operating instructions.

- » Turn radio off prior to entering any area with a potentially explosive atmosphere, such as gas, petroleum, chemicals, blasting caps, etc.
- » Do not charge the radio/battery in a potentially explosive atmosphere.
- » Do not use any portable radio that has a damaged antenna, as it can burn skin.
- » This equipment is to be serviced only by authorized RCA Communications Systems technicians. Any service performed by unauthorized technicians will void the warranty.
- » Turn radio off when near electrical blasting caps to avoid possible interference with blasting operations. Obey posted signs such

as those in hospitals or blasting areas advising people to turn off all two-way radios. Obey pilot and flight attendant instructions to turn radios off on airplanes.

- » Do not place a radio over an airbag or in an air bag's deployment area, as the force with which an airbag is inflated could propel the radio and may cause serious injury.
- » Do not place the radio close to a heat source or expose the radio to direct sunlight for an extended period of time.
- » Hold the radio in a vertical position with the microphone at least one inch away from your mouth when transmitting.
- » While wearing a transmitting radio, keep the radio and its antenna at least one inch away from your body.

Only use RCA approved accessories this radio. For a complete list of RCA approved antennas, batteries, chargers, holsters and audio accessories, visit:

www.RCACommunicationsSystems.com

PRODUCT INSPECTION

Prior to unpacking your BR200 portable radio, please inspect the packaging for signs of damage and report any damage or missing components immediately to your RCA Communications Systems Sales and Service Center. Every BR200 radio comes with the following items:

#	Item	Qty.
1	BR200-Handheld Radio	1
2	B2017LI - Li-Ion Battery (1700 mAh)	1
3	ANH200 - Antenna	1
4	BC200 - Belt Clip and 2 screws	1
5	Instruction Manual	1
6	Hand Strap	1
Items below will ship separately		
7	CH2001 PKG - Single Rapid-Rate Charger	1
8	PS2001 - Single Charger Power Supply	1



BR200
Handheld Radio



B2017LI
Li-Ion Battery (1700mAh)



Antenna
ANH200U-6 - UHF models
ANH200V-6 - VHF models



BC200
Belt Clip

* Items sent in separate box if ordered.



CH2001
Desktop Rapid Charger



PS2001
Power Supply

RCA BR200™ Overview

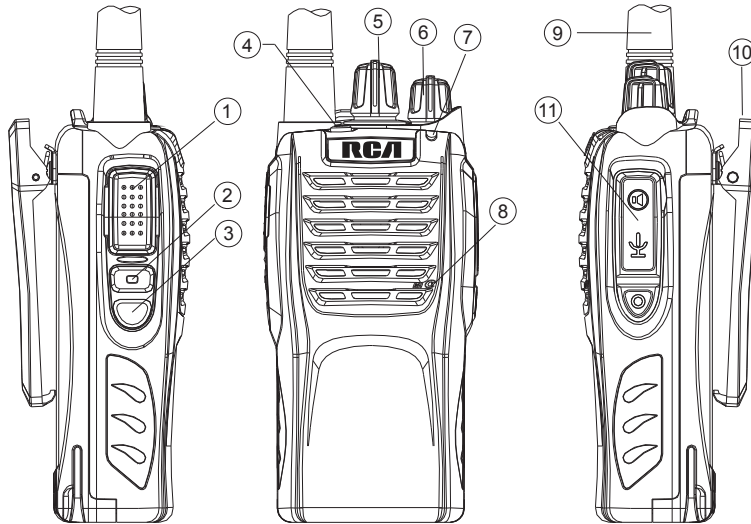

- ❶ Push-to-Talk (PTT) Button
- ❷ Programmable Button 1*
- ❸ Programmable Button 2*
- ❹ Programmable Button 3*
- ❺ Channel Selector
- ❻ On/Off/Volume Knob
- ❼ LED Indicator
- ❽ Microphone
- ❾ Antenna
- ❿ Belt Clip
- ⓫ Audio Accessory Connector

* These buttons are programmable by your RCA Communications Systems Dealer upon request..

Note: The frequency band of your BR200™ is on the radio label. If it is not visible, identify the frequency band according to the color circle on the antenna: white indicates UHF and red indicates VHF.

PREPARING YOUR RADIO FOR INITIAL USE

Setting Up The Charger

1. Plug the adapter's AC connector into the AC outlet socket. (See Figure 1)
2. Plug the adapter's DC connector into the DC socket on the back of the charger. (See Figure 2)
3. Place the radio with the battery attached, or the battery alone, in the charger. (See Figure 3 on page 7.)
4. Make sure the battery contact is touching the charging terminals. The charging process begins when the red LED light on the battery charger illuminates.
5. The green LED light on the battery charger will illuminate approximately two hours later, indicating the battery is fully charged.

Figure 1

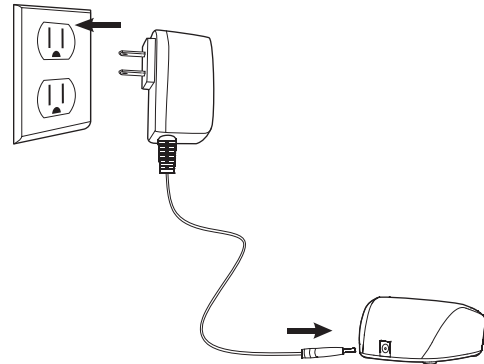

Figure 2

BATTERY INFORMATION

Charging the Battery

Your radio is powered by a Lithium-Ion (Li-Ion) battery. To avoid damage and comply with warranty terms, charge the battery using only an original RCA charger, exactly as described in the charger user guide.

Insert the battery or the radio to be charged into the charger slot. NOTE: The radio MUST be turned off before it is inserted into the charger. Make sure the battery is in good contact with the charger terminals. When the solid red indicator comes on, the charger has started to charge the battery.

When the charger's LED flashes red, the charger has entered a protective state and will no longer charge the battery. This may occur if the ambient temperature is too high or battery is damaged. When the LED illuminates green, the battery charge is complete. NOTE: Charge a new battery 12 to 14 hours before initial use for best performance.

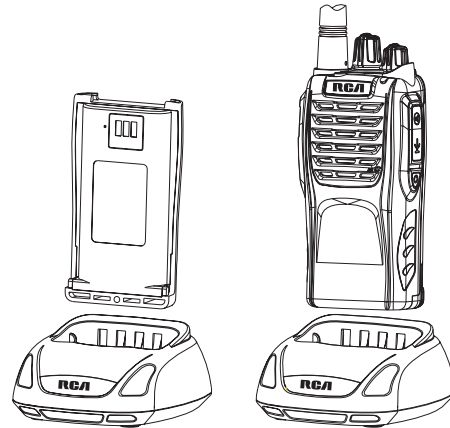

Figure 3

Maximum battery capacity is normally achieved after two or three full charge/discharge cycles.

Battery Caution

To reduce the risk of injury, use only batteries specified by RCA Communications Systems.

- » To avoid risk of personal injury, do not dispose of batteries in a fire.
- » Dispose of batteries according to local recycling regulations. Do not dispose as household waste.
- » Never attempt to disassemble the battery.
- » When charging a battery, keep it at a temperature between 41°F ~ 104°F (5°C ~ 40°C) to ensure a full charge. Temperatures outside this range significantly reduce battery life. The operating time (talk-time and standby time) is noticeably shorter than normal, replace the battery.
- » Before charging a battery attached to a radio, turn the radio off to ensure a full charge. Never leave a radio on while in the charger, as it can damage both the battery and the radio; the charger is not a radio stand.
- » Do not cut off the power supply or remove battery while charging.
- » Never charge a battery that is wet. Dry it with soft cloth prior charging.
- » The battery will eventually weaken. When the operating time (talk-time and standby time) becomes noticeably shorter than normal, replace the battery.
- » Battery performance greatly decreases at temperatures below -4°F (-20°C). Having a spare battery is always necessary in extremely cold environments. A cold battery may work again when it returns to room temperature, so keep it for later use.
- » Dust on the battery contact may cause the battery not to work or charge properly. Use a clean dry cloth to wipe it before attaching the battery to the radio.
- » Batteries with damaged contacts can be extremely dangerous. Any battery with damage to one or more contacts should be replaced immediately and not used under any circumstances.

Battery Storage

1. Fully charge a battery before storing it for an extended period of time to avoid battery damage due to over-discharge.
2. Recharge a battery after three months storage to avoid reduced battery capacity due to over-discharge.
3. When storing a battery, keep it in a dry place at room temperature.

Attaching the Battery

1. Place the battery in the groove on top of the chassis on the back of the radio. (See Figure 4)

2. Press the battery button down on the radio body and slide the battery under the belt clip connection until the battery clicks into place.

Note: If the battery is not securely locked, remove it and reattach it.

Figure 4

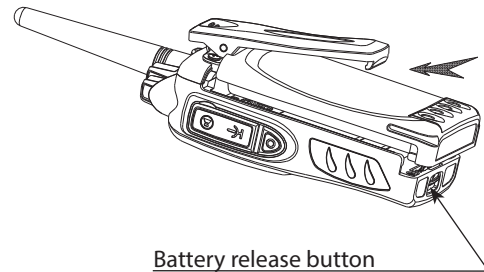

Attaching/Removing the Antenna

1. With the radio turned off, set the antenna in its receptacle and turn clockwise until it is screwed down. (See Figure 5)
2. To remove the antenna, turn the radio off and turn the antenna counterclockwise.

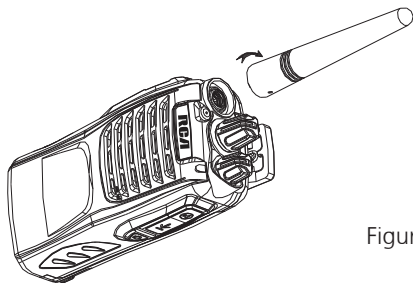

Figure 5

Attaching/Removing the Belt Clip

Using a small screwdriver, align the belt clip's screw holes to the radio's chassis. Attach by turning the screws clockwise into the belt clip's screw holes. Remove by doing the reverse.

(See Figure 6)

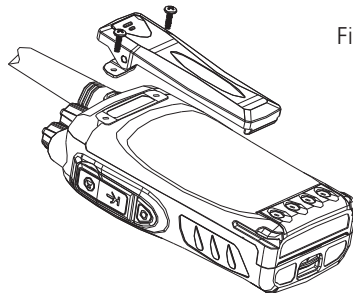

Figure 6

Connecting External Accessories

The accessory connector is located on the side of the radio. It is used to connect RCA audio accessories to the radio. Be sure the accessory plug is properly aligned and firmly connect the desired audio accessory into the accessory jack. (See Figure 7)

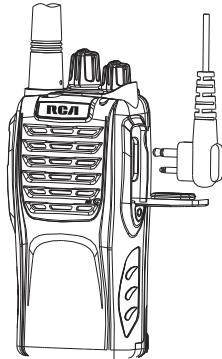

Figure 7

BASIC OPERATIONS

Turn Radio On/Off

Rotate the On/Off/Volume Control Knob clockwise until you hear a click. (See Figure 8)

The LED blinks green and a brief tone sounds, indicating that the power up test is successful. To turn off the radio, rotate this knob counterclockwise until you hear a click.



Figure 8

Note: *There is no power up tone if the radio tones/alerts function is disabled. If your radio does not power up, check your battery and make sure it is charged and properly attached. If your radio still does not power up, contact your RCA Communications Systems dealer.*

Adjusting the Volume

To increase the volume, turn the On/Off/ Volume Control Knob clockwise. To decrease the volume, turn this knob counterclockwise. (See Figure 8)

Select a Channel

Rotate the channel selector to the desired channel. If channel annunciation has been set, the current channel number will sound. When a signal is received, it will be heard through the speaker. (See Figure 9)

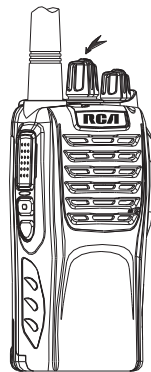

Figure 9

Make a Call

To make a call, press the PTT (Push To Talk), and speak in normal voice. Please keep your mouth about 3-4 inches (10 cm) away from the microphone for best voice quality.

Receive a Call

Release the PTT button and adjust the volume so you can hear inbound calls.

Your RCA Communications Systems Dealer can set CTCSS/DCS, 5-Tone or 2-Tone or MDC on selected channels upon request. On the channels programmed with Selective Signaling, you will not hear calls except those from the radios in the same group and sending the proper ID signal.

PROGRAMMABLE BUTTONS

Your RCA Communications Systems Dealer can set the programmable buttons as shortcuts to radio functions or preset channels/groups depending on the duration of a button press: Short Press = Press and release quickly. Long press = Press and hold for the programmed duration (between 1 second and 3.75 seconds).

Your RCA Communications Systems Dealer can program the Side Button 1, Side Button 2 and the Top Button with the following optional functions:

1. Annunciation Selection - Disable or enable the Channel Annunciation function.
2. Battery Check – Checks the battery charge level. If you hear “Very Low Battery”, then the radio should be charged as soon as possible.
3. Call Forward – Forwards a call to another radio.
4. Call1/Call2/Call3/Call4 - Press the button set as “CALL 1/CALL 2/CALL3/CALL4” to transmit the stored code.

5. Cancel Emergency Call - Cancels an emergency alarm or call.
6. Emergency Call - Initiates an emergency alarm or call where the radio can sound alarm, transmit an ID code or transmit a background tone to system partners.
7. H/M/L Power Switch - Toggles between high, medium and low power.
8. Key Lock -Locks or unlocks the following keys: Channel knob, Annunciation Selection , Talk Around, Lone Worker, Scan, Noise Channel Delete, Call Forward, H/M/L Power Switch, Squelch Adjust, Normal Record/Record Stop, Protected Record/Record Stop, Record Delete, Surveillance or other keys.
9. Lone Worker – This setting keeps track of radio users who are alone. In Lone Worker mode, the radio will sound a pre-alert tone at a preset time, which lets the user know they must press any key on the radio to indicate they are safe. If a radio key is not pressed in the time allotted, the radio will automatically initiate emergency procedures.
10. Monitor Momentary/Call Cancel - Turns off CTCSS, DCS, 5-Tone, 2-Tone and MDC so signals that cannot be heard in normal mode can be heard. Release the Monitor key to return to normal mode.
11. Monitor/Call Cancel – Sets the side button to “Monitor” to turn off CTCSS, DCS, 5-Tone, 2-Tone and MDC so signals that cannot be heard in normal mode can be heard. Press again the Monitor key to return to normal work.
12. Noise Channel Delete - When scanning pauses on an unwanted channel, press and hold the “Noise Channel Delete” button to temporarily delete the channel from your scanning list. When you exit and reenter scanning mode, the temporarily deleted channel will be reinstated to the scanning list. Note: The priority channel cannot be deleted.
13. None (No Function).

14. Normal Record/Record Stop – Starts/stop transmission recording. One beep indicates recording has started, two beeps indicate the recording has stopped.
15. Protected Record/Record Stop – Similar to Normal Record, however, conversations cannot be deleted by using “Record Delete” button.
16. Record Delete – Deletes Normal Record conversations.
17. Record Play/Play Next/Play Stop - Plays back recorded conversations. The latest recording will be played when the key is first pressed. Press the key again to hear next recording. When all the recordings have been played, playback will stop.
18. Scan - Toggles scan on or off.
 - a. If scan beep tone is enabled, 4 high beeps will indicate entering scanning state, or 4 low beeps indicate exiting scanning state. If scan LED enabled, the RED LED will blink while scanning.
 - b. The working channel of the radio will revert to your defined channels automatically when you press PTT button during scanning.
19. Squelch Adjust - Changes the squelch level.
20. Squelch Off Momentary/Call Cancel – Turns on/off squelch as long as the button is pressed.
21. Squelch Off/Call Cancel - “Squelch off” turns the squelch on and off.
22. Surveillance – Eliminates external radio noises and LED lights.
23. Talk Around - Disable or enable Talk Around function. Talk Around enables the radio to transmit with the RX frequency of the channel.
24. VOX On/Off - Allows hands-free radio transmissions when using a VOX capable earphone/headset. VOX can be programmed to transmit automatically when your voice reaches a preset volume.

OTHER PROGRAMMABLE FEATURES

Battery Save Mode

Battery Save Mode automatically reduces the draw on your radio's battery if it is not used for a set period of time. The radio automatically exits Battery Save Mode when a call is received or a transmission is made. Ask your RCA Communications Systems Dealer about the different battery saving modes that are available to increase battery active time.

Channel Annunciation

When rotating the channel knob, the channel number will be announced.

CTCSS/DCS

One or more channels on your radio can be pre-programmed with Continuous Tone-Coded Squelch System (CTCSS)/Digital Coded Squelch (DCS) signaling. This feature is activated when it receives a matching CTCSS/DCS signal, which causes the radio to ignore extraneous calls on the same

channel. Multiple radios can be programmed with specific CTCSS/DCS signaling so they can be part of a group. Note: Using CTCSS/DCS programming doesn't mean your calls are private. If the CTCSS/DCS tones on other radios match yours, the other radios will hear your transmissions.

Low Battery Warning

A Low Battery Warning tone sounds and the LED flashes when battery power goes below a preset value. If the battery voltage is too low, your radio will not be able to transmit.

Man-Down (Optional)

Monitors if the radio is vertical or horizontal. "Man-Down" feature means the radio is horizontal for longer than normal, which causes the radio to emit pre-alert tones. If the radio is not returned to a vertical position, the radio will enter "Emergency State."

Priority Scan

Your radio can be programmed with a priority channel for important transmissions. If you are

using the scan feature and a transmission is received on the priority channel, the radio will override the normal scan pattern and go directly to the priority channel. The radio will stay on the priority channel until the signals stop. Your RCA Communications Systems Dealer can program the time between the end of the signals and the continuation of the scan

Scan

When in scan mode, your radio will switch between channels in search of an incoming transmission. If a signal is detected, the radio will pause on the channel until the transmission stops. If a delay time has been programmed between the transmission stop time disappearing and the scanning restart time, the radio will stay on the channel to see if a new transmission is received during the delay.

There are multiple scan options that can be programmed into your radio. Your RCA Communications Systems Dealer will help you determine the scan option that best meets your needs.

Temporarily Delete Noise Channel

When scanning pauses on a channel that you want to temporarily remove from the scan list, press and hold the button programmed as "Temporarily Delete Noise Channel." This will remove the channel until the radio is turned off. When the radio is powered up again, the removed channel will return to the scan list. Note: The priority channel cannot be deleted from the scan list.

TOT (Time-out Timer)

TOT Dispatch Time

The TOT Dispatch Time is the maximum amount of time a radio is allowed to transmit continuously in normal dispatch mode. This feature helps reduce battery draw if a radio is accidentally stuck in transmit mode. If the radio continues transmitting after the pre-programmed time expires, the radio will generate a warning tone and automatically stop transmitting. When the radio is in TOT mode, inbound calls can be heard, but the radio will not transmit.

TOT Re-key

1. TOT Re-key sets the amount of time transmissions are prohibited after the time-out timer has been activated.
2. If transmitting is prohibited, pressing the PTT button will cause a warning tone.

TOT Pre-alert

1. The radio emits a pre-alert tone indicating that radio will soon stop transmitting due to the TOT.
2. After the alarm tone, if the transmission continues past than the preset time limit, the TOT will be activated, which prevents the radio from transmitting.

TOT Reset

1. TOT Reset is the delay time between releasing the PTT button and resetting the Time-Out Timer.
2. If the time of releasing the PTT button is shorter than the TOT Reset, the transmitting prohibition countdown will continue.

TROUBLESHOOTING

Problem	Solution
The radio cannot be switched on or no display after switched on.	<ul style="list-style-type: none"> • Battery pack may not be installed properly. Remove the battery pack and install it again. • Battery power may be insufficient. Recharge or replace the battery pack.
The battery power runs out quickly after charging.	<ul style="list-style-type: none"> • Battery is worn out. Replace with a new battery.
Cannot talk to or hear other members in your group.	<ul style="list-style-type: none"> • Determine if other callers are using the same channel. • CTCSS/DCS signaling may not be identical. Please talk to your RCA Communications Systems dealer about reprogramming. • Make sure the setting of the selective signaling 5-Tone in the RX Squelch Mode is correct. • Members are outside of communication range.
Other calls from non-group members are heard on the channel.	<ul style="list-style-type: none"> • Talk to your RCA Communications Systems dealer about changing the CTCSS/DCS tone. Be sure the CTCSS/DCS tone is the same on all radios in your group.

Problem	Solution
Communication range is too small.	<ul style="list-style-type: none">• Check to see if the antenna is securely fastened.• Check to see if the antenna is the made specifically for your radio.• Check if the battery is properly charged.• Ask your RCA Communications Systems dealer to adjust the squelch level.
Unable to transmit.	<ul style="list-style-type: none">• Make sure the PTT button has been pressed completely.• Battery power may be insufficient. Recharge or replace the battery.• Transmitting frequency has not been set on the channel and the radio has been remote killed.• Time Out Timer (TOT) is preventing transmissions.
Noise is too loud.	<ul style="list-style-type: none">• Check if the battery is properly charged. Recharge or replace the battery.• Other callers are beyond efficient communication range.

CARE AND CLEANING

- Do not directly handle the radio by its antenna or external microphone.
- Do not place the radio in a dusty or dirty environment.
- Clean the radio with a lint-free cloth moistened with clean water and/or a mild dish washing liquid to remove dirt, grease, and dust.
- Avoid subjecting the radio to corrosives, solvents or spirits.

ACCESSORIES



3" Stubby Antenna - More compact and convenient than a Standard Antenna, but reduces coverage by approximately 30%

VHF - ANH200V-3 136-150

VHF - ANH200V-3 150-174

UHF - ANH200U-3 400-440

UHF - ANH200U-3 440-470

UHF - ANH200U-3 450-520



6" Standard Antenna - For the best reception and coverage.

VHF - ANH200V-6 136-174

VHF - ANH200V-6 150-174

UHF - ANH200U-6 400-440

UHF - ANH200U-6 440-470

UHF - ANH200U-6 450-520



Battery

B2017LI

7.4V, 1700mAh Li-Ion Battery

B2020LI

High capacity 7.4V, 2000mAh Li-Ion Battery

ACCESSORIES *CONTINUED*

Heavy Duty, Remote Speaker Microphone

SM310-X03

No need to remove the radio from your waist, which helps prevent radio damage or loss.



Medium Duty, Remote Speaker Microphone

SM220-X03

No need to remove the radio from your waist, which helps prevent radio damage or loss.

ACCESSORIES *CONTINUED*

Professional Listen-Only Earpiece w/ Transparent Acoustic Tube (For use with remote speaker microphone)
SK01NE-X03
Lightweight earpiece for use with optional speaker mics or when transmitting is not necessary.



Economy Listen-Only Earpiece
(For use with remote speaker microphones)
SK01EH-X03
Same functions as the professional earpiece but at economical price.



Ear-Hook Style Earpiece with Microphone PTT
SK11EH-X03
Serves the same function as the professional surveillance kit at an economical price.

ACCESSORIES *CONTINUED*

Surveillance Kit with Palm Mic and In-Line PTT

SK11NE-X03

Professional, high quality earpiece ideal for radio users requiring discreet communication.



Lightweight Over-The-Head Headset with In-line PTT

HS21V-X03

Durable and inexpensive. Perfect for retail stores, restaurants and bars.



Heavy Duty, Over-The-Head Headset

HS61NR-X03

For use in high noise environments such as airports, race tracks and manufacturing plants (-24dB noise reduction).

ACCESSORIES *CONTINUED*

Professional Heavy Duty, Behind-the-Head Headset

HS71NR-X03

When a hard hat is necessary in high noise environments.



Leather Holster (Fixed or swivel clip)

HL200FC - Fixed Clip**HL200SC - Swivel Clip**

Stronger and more durable than Nylon. Offers the best protection for your BR200™ radio.



Nylon Holster (Fixed or swivel clip)

HN200FC - Fixed Clip**HN200SC - Swivel Clip**

Secures the radio to your waist and protects your radio from “bumps and bruises.”

ACCESSORIES *CONTINUED*



Single Rapid-Rate Charger Kit
CH2001 PKG
Includes single charger and power supply



Multi-Unit Rapid-Rate Charger Kit
CHU6 PKG
Includes 6 unit charger and power supply



Waterproof Bag
HNWATPROOF
Protect your BR200™ radio when working around water.

WARRANTY STATEMENT

RCA Communications Systems warrants each new radio product it supplies to be free from defects in material and workmanship under normal use and service for the time period listed below, provided that the user has complied with the requirements stated herein.

The warranty period begins on the date of purchase from an authorized RCA Communications Systems Sales and Service Center. This warranty is offered to the original end user and is not assignable or transferable. RCA Communications Systems is not responsible for any ancillary equipment which is attached to or used in conjunction with RCA Communications Systems products.

RCA Communications Systems offers to the original end user a Three (3) Year Limited Warranty on the RCA BR200™ Radio Handset. The BR200™ Antenna, BR200™ Battery and the BR200™ Battery Charger are covered under a One (1) Year

Limited Warranty. The BR200™ Belt Clip is not covered under the warranty.

During this period, if the product fails to function under normal use because of manufacturing defect(s) or workmanship, it should be returned to the Authorized RCA Communications Systems Sales and Service Center from which it was purchased. The Sales and Service Center will repair the product to full operating specifications or replace the product with a new product of the same make and model. The user is responsible for all charges incurred in returning the product to the Authorized RCA Communications Systems Sales and Service Center. RCA Communications Systems will be responsible for all charges in returning the product to the end user via standard ground shipping service.

RCA Communications Systems shall have no obligation to repair or replace the product if there is damage as a result of normal “wear and tear”

or if the damage is caused in whole or in part by catastrophe, fault or negligence of the user, improper or unauthorized alterations or repairs to the product, incorrect wiring, use of the product in a manner for which it was not designed, or by causes external to the product. The radio equipment warranty does not cover physical or liquid damage, which includes, but is not limited to, liquid damage, damaged screen, deep scratches, bent or broken body or frame, damaged channel or volume controls, damaged antenna, charging and/or accessory ports. This warranty is void if the product serial number is altered, defaced or removed.

THE EXPRESS WARRANTIES CONTAINED HEREIN ARE IN LIEU OF ALL OTHER WARRANTIES, EITHER EXPRESSED OR IMPLIED OR STATUTORY, INCLUDING, WITHOUT LIMITATION, ANY WARRANTY OF MERCHANTABILITY OR FITNESS FOR A PARTICULAR PURPOSE.

FOR ANY PRODUCT WHICH DOES NOT COMPLY WITH THE WARRANTY SPECIFIED, THE SOLE

REMEDY WILL BE REPAIR OR REPLACEMENT. IN NO EVENT WILL RCA COMMUNICATIONS SYSTEMS BE LIABLE TO THE BUYER OR ITS CUSTOMERS FOR ANY DAMAGES, INCLUDING ANY SPECIAL, INCIDENTAL, INDIRECT OR CONSEQUENTIAL DAMAGES, OR THE LOSS OF PROFIT, REVENUE OR DATA ARISING OUT OF THE USE OR THE INABILITY TO USE THE PRODUCT.

RCA Communications Systems endeavors to achieve the accuracy and completeness of this manual, but is not liable for any possible omission and printing mistakes.

All the above specifications and design are subject to change without prior notice.

All the reproduction and translation of this manual without authorization is prohibited.

All the above specifications and design are subject to change without notice due to continuous development.

No part of this manual may be copied, reproduced,

translated, stored in a retrieval system, distributed, or transmitted in any form or by any means, electronic or mechanical, for any purpose without the expressed, written permission from RCA Communications Systems.

The end-user of any two-way radio is solely responsible for obtaining any license or other authorizations required by the Federal Communications Commission (FCC). For further information visit www.fcc.gov or call 1-888-CALL-FCC (1-888-225-5322).

RF Exposure Compliance

To control your exposure and ensure compliance with the occupational/controlled environment exposure limits always adhere to the following procedures.

Guidelines:

Do not remove the RF Exposure Label from the device.

User awareness instructions should accompany device when transferred to other users.

Do not use this device if the operational requirements described herein are not met.

Operating Instructions:

Transmit no more than the rated duty factor of 50% of the time. To transmit (talk), push the Push-To-Talk (PTT) button. To receive calls, release the PTT button.

Transmitting 50% of the time, or less, is important because this radio generates measurable RF energy exposure only when transmitting (in terms of measuring for standards compliance). Hold the radio in a vertical position in front of face with the microphone (and the other parts of the radio, including the antenna) at least one inch (2.5 cm) away from the mouth. Keeping the radio at the proper distance is important because RF exposures decrease with distance from the antenna. Antenna should be kept away from eyes.

When worn on the body, always place the radio in an approved clip, holder, holster, case, or body harness designed for this product.

Using approved body-worn accessories is important because the use of or other manufacturer's non-approved accessories may result in increased exposure levels, which can exceed the FCC's occupational/controlled environment RF exposure limits.

If you are not using a body-worn accessory and are not using the radio in the intended use position in front of the face, then ensure the antenna and the radio are kept at least one inch (2.5 cm) from the body when transmitting. Keeping the radio at the proper distance is important because RF exposure decrease when increasing distance from the antenna.

Use only RCA Communications Systems approved supplied or replacement antennas, batteries, and accessories. Using non-RCA antennas, batteries, and accessories may exceed the FCC RF exposure guidelines and is not recommended.

BR200 Specifications	
Frequency Bands	136~174 MHz VHF 400~470 MHz UHF
RF Power	5W/4W / 1W
Spurious and Harmonics	≤-70 dB
Frequency Stability	±2.5ppm
Maximum Frequency Deviation	±2.5 kHz (N) / ±5kHz (W)
Receiver Sensitivity	Narrow Band ≤0.28μV Wide Band ≤0.25μV
Adjacent Channel Selectivity	≥60dB (N) / 70dB (W)
Intermodulation Rejection	≥65dB
Maximum AF Output Power	≥1000mW
Number of Channels	16
Standard Battery	DC 7.4V
Dimension (W×H×D)	4.5" x 2.1" x 1.3" 113mm x 54.5mm x 35mm
Weight	12.5 oz/355g W/Battery and Antenna

Page Left Blank

ADVANCED RADIO SYSTEMS
8726 NW 26th Street Unit 6
Doral, FL. 33172

305-884-1795 www.MyRadioMall.com



www.RCACommunicationsSystems.com

© 2015 RCA Communications Systems. All rights reserved.